

MEMO

Card Printer

B5A-3133-00

Model **K30 Series / K60 Series**

Thank you for purchasing this product.

Please read through the manuals carefully in advance to ensure proper use of this product. Also, to make sure that the product is used safely, please read through the "Safety Precautions" in the "READ ME FIRST" booklet. Please store the manuals properly after reading so that they can be referred to whenever necessary.

Place this "Instruction Manual" near the printer and use it as and when needed.

Accessories

- Instruction Manual.....1
- READ ME FIRST :LST1004.....1
- Power Cord (2 m)2
- Cleaning Card1
- Card Stacker1
- USB 2.0 Cable (2 m)1
- Gloves1
- Tweezers1

Products Sold Separately

To purchase these items, consult our authorized dealers.
Use the retransfer film or ink ribbon within half a year after purchase.

- Ink Ribbon / Retransfer Film (AD Series, BA Series)
- Cleaning Kit, Model: CX210-CKIT2
Magnetic Head Cleaning Card (5 Pcs),
Cotton Swab (5 Large and 5 Small), Cleaning Wipes (1 Box)
- Cleaning Card, Model: CX210-CC1
10 Pcs/Set

Specifications

- Operating environment conditions
AD Series Ink Ribbon / Retransfer Film
Temperature: 15 °C to 30 °C
(When peel-off ink, UV ink is used: 17 °C to 28 °C)
Humidity: 35 % to 70 % No condensation
(When peel-off ink, UV ink is used: 35 % to 60 %)
BA Series Ink Ribbon / Retransfer Film
Temperature: 20 °C to 30 °C
Humidity: 35 % to 70 % No condensation
- Storage environment conditions
<Printer unit>
Temperature : -15 °C to 55 °C
Humidity : 20 % to 80 %
<Printing media (retransfer film or ink ribbon) / card>
Temperature : 5 °C to 25 °C
Humidity : 40 % to 60 %
- Power supply..... AC 100 V - 120 V, 50 Hz/60 Hz
AC 220 V - 240 V, 50 Hz/60 Hz
- Power consumption..... 310 W
(maximum power when all options are installed)
- Current consumption..... 3.5 A (100 V system)
1.6 A (200 V system)
- Mass..... approx. 13.7 kg
(double-sided printer, including bend remedy unit)
- Dimensions 343 mm x 335 mm x 322 mm (W x H x D)

* The specifications and appearance of this product may be modified for improvement without prior notice.

Function & Option Checklist

Use the checklist below to identify the functions and options of the printer in use. Tick accordingly.

Model name:

Function	
Single-sided Printing	Double-sided Printing

Option			
Bend Remedy unit	Magnetic Encoder	Contact IC Encoder	Non-contact IC Encoder

Japan
Kanematsu Corporation
2-1,Shibaura 1-chome,Minato-ku,
Tokyo 105-8005, Japan
TEL : 81-3-5440-8470

U.S.A.
Kanematsu USA Inc.
100 Randolph Road Somerset,
New Jersey 08873, U.S.A.
TEL : 1-732-271-7300

Germany
Kanematsu G.m.b.H.
Oststrasse 34, D-40211
Duesseldorf, Germany
TEL : 49-211-36890

Name of Parts

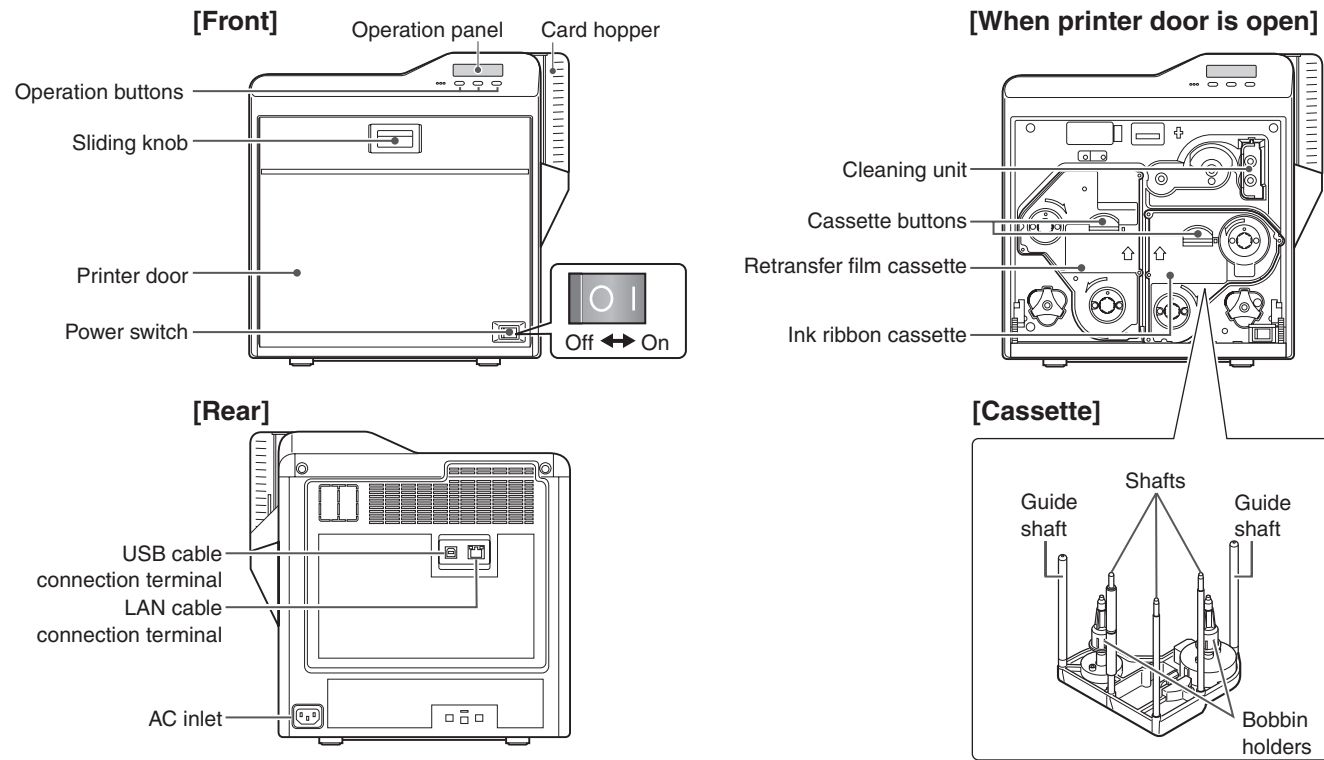

Replacing the Retransfer Film/Ink Ribbon

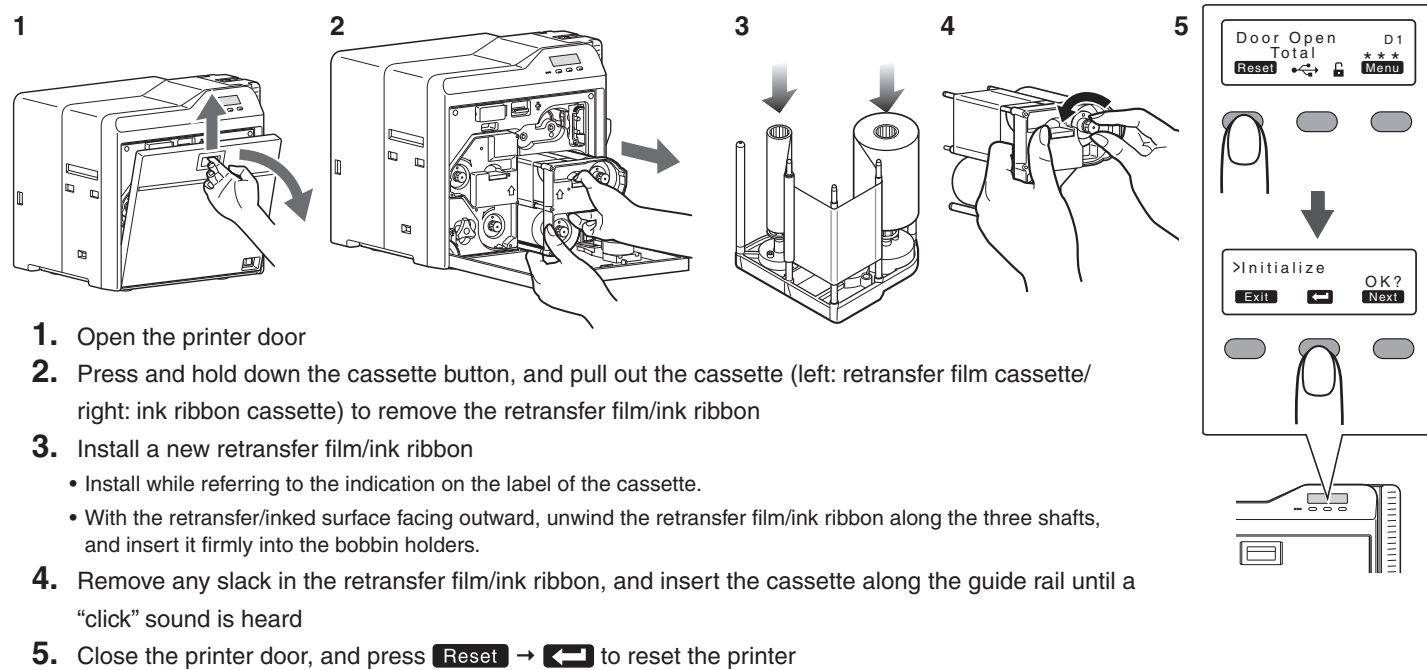

Precautions

- If the security lock is on, deactivate it. After work is complete, activate the security lock again.
- When installing a used ink ribbon, align the yellow side of the unused ribbon with the arrow indicated on the label of the cassette.
- When installing a used retransfer film, align the unused side of the film with the arrow indicated on the label of the cassette.
- Stand the cassette on a flat surface as illustrated in the diagram.
- The cassette is heavy when the retransfer film/ink ribbon is loaded. To prevent the cassette from dropping during handling, make sure to hold it with both hands.
- Do not touch the retransfer/inked face (the side that faces outward when installed) with your hand. Touching it may cause printing errors. Put on the supplied gloves when handling the retransfer film/ink ribbon.
- Do not perform any work on the printer door. Do not place heavy objects or apply load on the printer.
- When installing a new film, make sure that at least three black lines are wound onto the take-up side.

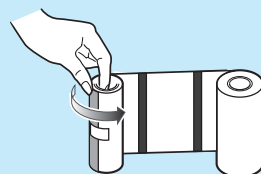
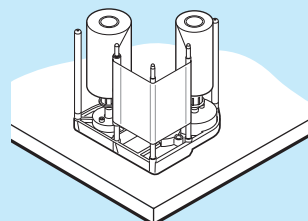

Printing a Card

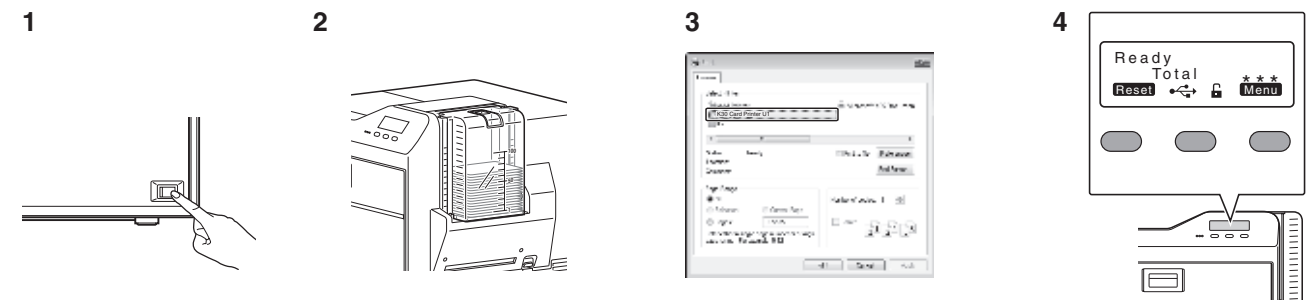

- Turn on the power
- Check to ensure that cards are inserted into the card hopper
- Open the software's print settings screen, and select this printer
- After ensuring that a [Ready] message appears on the LCD panel of the printer, start printing

Precautions

- If you see an [Initializing..] or [Preheating..] message on the LCD panel of the printer, this means the printer is not ready yet. Printing cannot be performed until a [Ready] message appears.
- Printing the card on the side with the magnetic stripe may cause printing errors or damage to the card's functions. If you want to do so, please consult our authorized dealers in advance.
- For printing using application software prepared by the user, refer to the instruction manual of the corresponding software.

Replenishing Cards

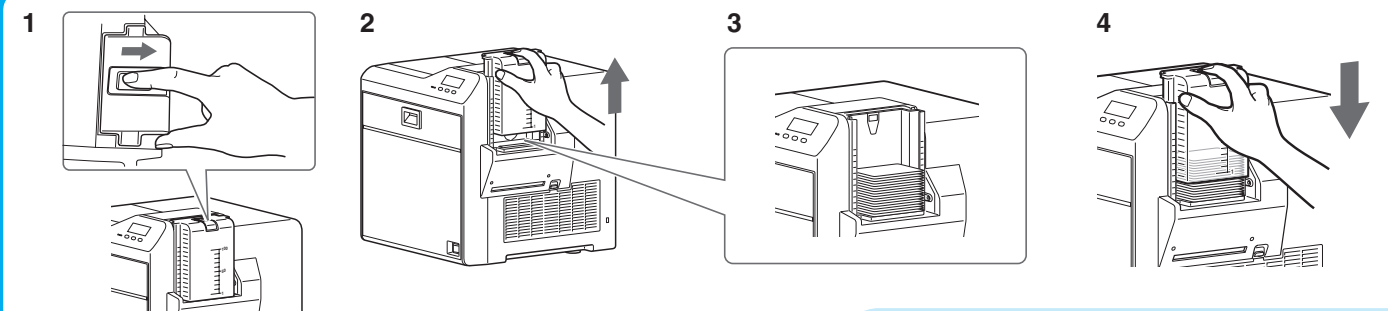

- Set the card hopper knob to [OPEN]
- Lift to remove the card hopper cover
- Align the orientation of the cards, and set them in the printer
- Install the card hopper cover, and set the card hopper knob to [LOCK]

Precautions

- If the security lock is on, deactivate it. After work is complete, activate the security lock again.
- Do not touch the printing surface of the card. Touching it may cause printing errors. Put on the supplied gloves when handling the cards.
- To prevent card jams from occurring, limit the number of cards stored in the card hopper at any time to about 100 pieces regardless of the card thickness.
- When using new cards, set them after making sure that they are not adhered to each other due to static.
- Align the cards before setting them in the printer. Otherwise, the card hopper cover may not close properly, and this may damage the printer.

Maintenance of Cleaning Roller

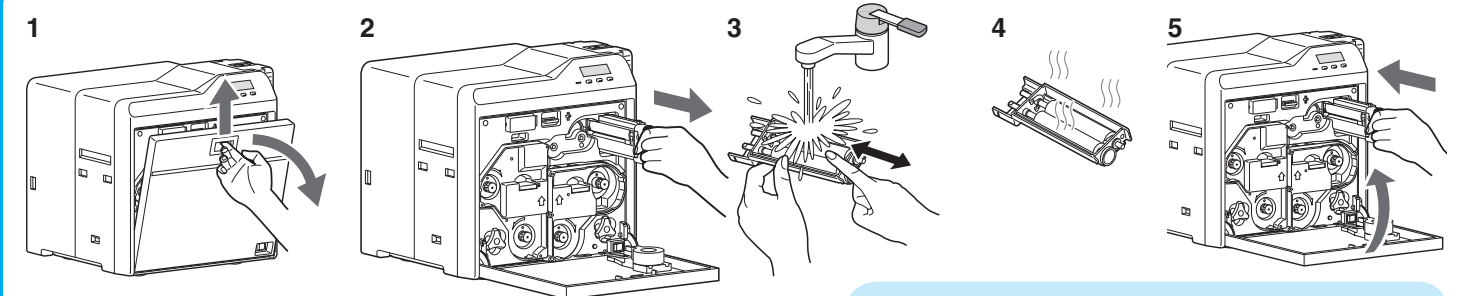

- Open the printer door
- Remove the cleaning unit
- Wash the cleaning roller with water
 - Wash the roller with water, and remove any dirt from the surface of the cleaning roller with your finger.
- Allow the cleaning roller to air dry
- Set the cleaning unit, and close the printer door

Precautions

- If the security lock is on, deactivate it. After work is complete, activate the security lock again.
- Start work after ensuring that the power has been turned off.
- If the printer is used every day, make sure to clean the cleaning roller daily at the end of the operation.
- After washing, allow the cleaning roller to dry completely before installing it to the printer.
- Do not wash the cleaning roller with anything other than water (e.g., alcohol).
- Replace the cleaning unit with a new one after using it for about one year. For details on its replacement, please consult our authorized dealers.